



SC 110

SEMI CYCLE BATTERY
12V | 110Ah | 650h

M31



Electrical Specifications

Nominal voltage	12V
Rated capacity	110Ah @ C ₁₀₀
Separator	PE
CCA at -18 °C	650A
Cycle Life in Relation to Depth of Discharge	600 Cycles at 30 % DoD
	360 Cycles at 50 % DoD
	250 Cycles at 80 % DoD
	170 Cycles at 100 % DoD

Discharge Specifications

Capacity C ₁₀₀	110Ah
Capacity C ₂₀	100Ah
Capacity C ₁₀	88Ah
Capacity C ₅	75Ah
Max. Discharge Current	900A (5 Seconds)

Charge Specifications

Maximum Charge Current	30A
Float Charge Voltage	2.23V to 2.25V @ 25°C
	Temp. Compensation: -3mV/°C/Cell
Cycle Use Voltage	2.23V to 2.25V @ 25°C
	Temp. Compensation: -3mV/°C/Cell

Mechanical Specifications

Measurements (L × W × H)	330 × 172 × 242mm
Approx. Weight	26.20kg
Terminal Type	Marine Twin
Hold-Down	B0
Case Material	PP
Lid Material	PP
Water consumption	W4
Charge Retention	C2
Vibration Resistance	V2
Endurance Level	E1

Temperature Specifications

Discharge Temperature	-15 to 50°C
Charge Temperature	0 to 40°C
Storage Temperature	-15 to 50°C
Normal Operating Temperature	25 ± 5°C

Measurements

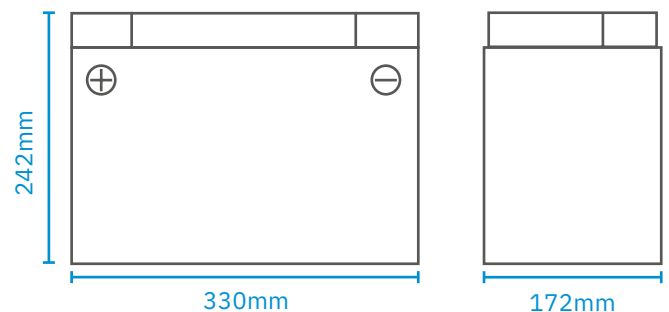

Discharge Characteristics Curve

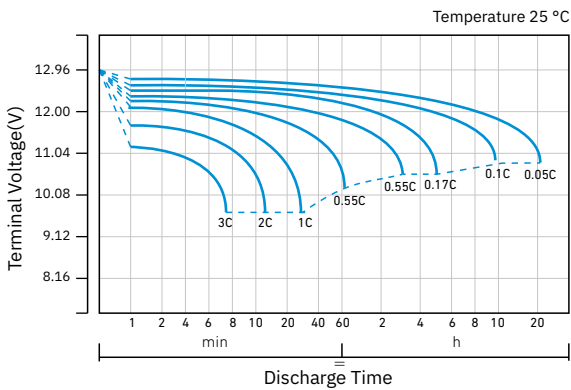

Charge Characteristics Curve For Cycle Use (IU)

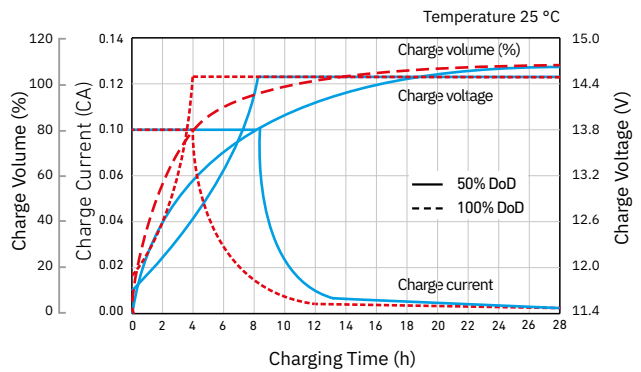

Relationship of Cycle Life and DoD

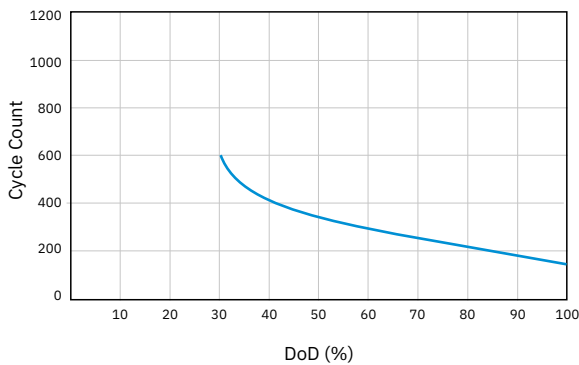

Relationship of Charge Voltage and Temperature

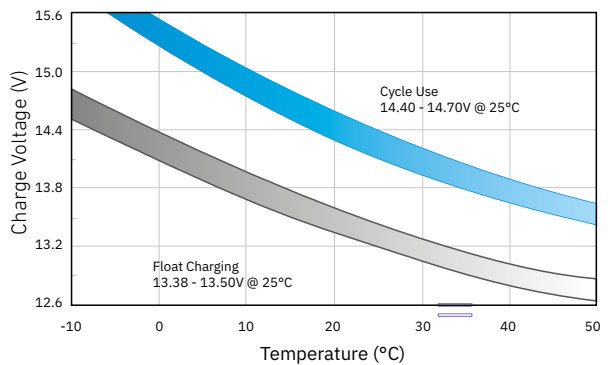

Temperature Effects on Capacity

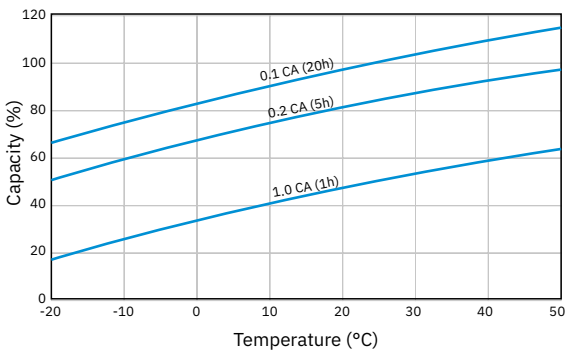

Storage Characteristics

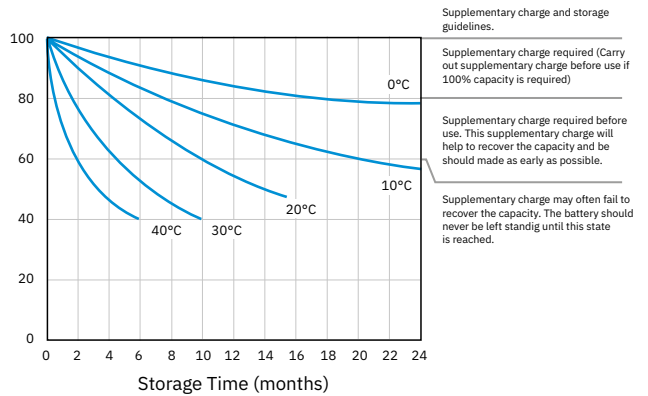

Effect of Temperature on Long-Term Life

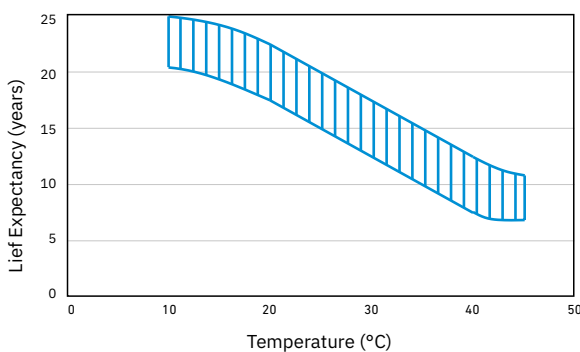

Relationship of OCV and State of Charge

