

CSI 10 PRO

Power Inverter | 1000 W | 12 V to 230 V | Pure Sine Wave

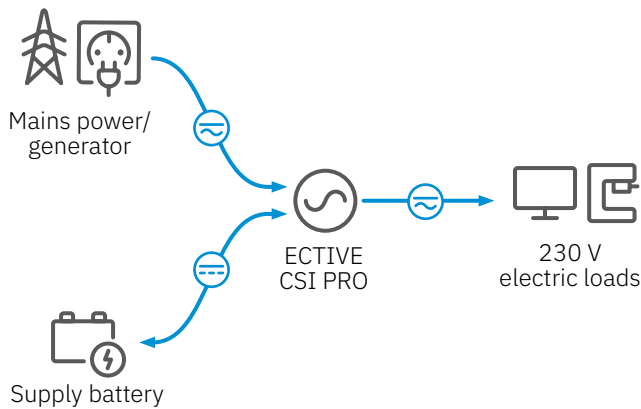

Versatile Power Supply



ECTIVE CSI PRO inverters convert direct current from a supply battery into high-quality alternating current with a pure sine wave. This means that sophisticated 230 V devices can be operated anywhere and anytime: exactly like with a power outlet at home.

The batteries are recharged easily and efficiently with mains power thanks to the integrated charger. In addition, numerous other features and safety functions guarantee a flexible, self-sufficient power supply.

Technical Specifications

Continuous power	1000 W
Max. Power up to 2 s	2000 W
Max. Power up to 10 s	1500 W
Input voltage	12 V
Output voltage	230 V
Efficiency (inverter)	up to 90 %
Charge voltage	10,2 to 15,0 V *
Charge current	20 A
Efficiency (battery charger)	up to 92 %
Dimensions (W x H x D)	380x220x150 mm
Weight (W x H x D)	5,1 kg
Direct current connection (DC)	M8

* depends on battery technology and charging phase

Features and Functions

- Alternating current with pure sine wave
- Integrated battery charger
- Battery priority circuit („ECO mode“)
- Mains priority circuit („UPS mode“)
- Provision of a TN power system
- Residual current circuit breaker with overcurrent protection (RCBO)
- Overload protection
- Short-circuit proof
- Soft start
- Over & under voltage protection
- Reverse polarity protection
- Overheating protection
- USB port for small devices (5 V / 1 A)

Required Battery Capacity

Battery capacity (Wet, Gel, AGM)	≥ 160 Ah
Battery capacity (LiFePO ₄)	≥ 90 Ah
Continuous discharge current (LiFePO ₄)	85 A

Battery Charging

ECTIVE CSI PRO inverters contain an integrated battery charger with which connected batteries can be easily charged with mains power. The inverter can be configured for any battery technology to ensure the safest and most efficient charging possible:



Simply use the DIP switch on the inverter’s housing to set the correct battery technology:

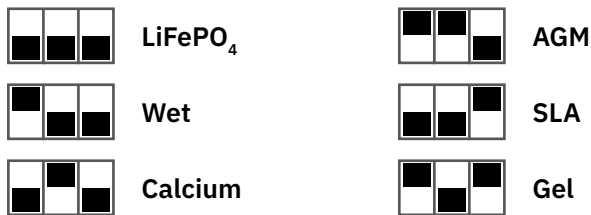

Several identical batteries can be connected to the inverter in parallel.

The charger works with a three-stage IUoU charging characteristic whose parameters are optimised for the respective battery technology:

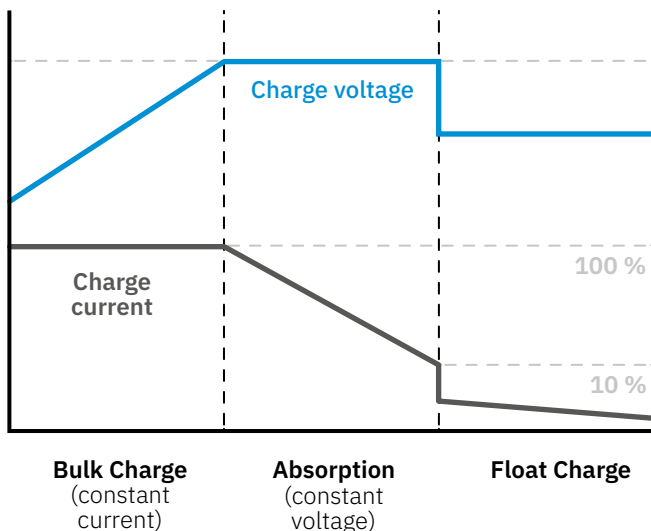

Parameters of the Safety Features

Overvoltage	16,5 ± 0,2 V
Return after overvoltage	15,2 ± 0,2 V
Impending undervoltage	10,8 ± 0,2 V
Absolute undervoltage	10,2 ± 0,2 V
Undervoltage (ECO mode)	11,0 ± 0,2V
Return after undervoltage	14,2 ± 0,2V
Switchover time (UPS mode)	16 ms
Overheating	>75 °C
Working temperature	-15 to 40 °C
Storage temperature	-40 to 85 °C

Dimensions

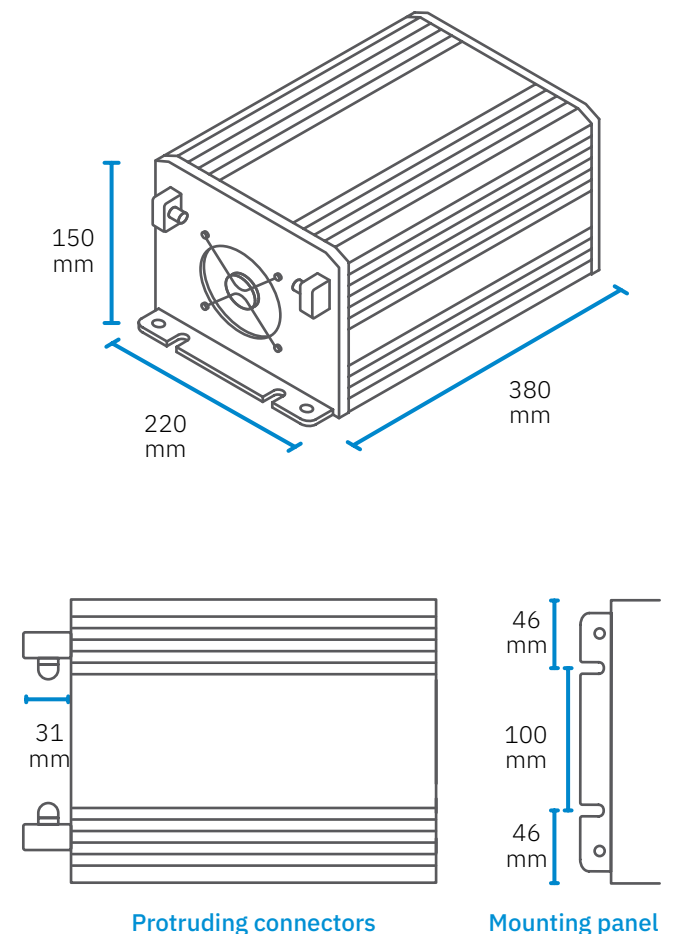

The CSI PRO in the ECTIVE Ecosystem

Inverters from the ECTIVE CSI PRO series fit perfectly into the ECTIVE ecosystem, as they are compatible with batteries of all technologies. Thanks to the integrated battery charger, you can easily and keep your batteries charged using mains power. By adding an ECTIVE MPPT solar charge controller, you can even use solar power to keep your batteries charged independently. This means that nothing stands in the way of an absolutely self-sufficient and mobile power supply that consists entirely of high-quality and perfectly harmonised ECTIVE products.

Would you like to add the right ECTIVE components to your system?
Find out more at [ective.de](https://www.ective.de)!

ECTIVE RC PRO

Simply connect the ECTIVE RC PRO remote control to your ECTIVE PRO inverter via the included RJ12 cable to easily monitor various relevant system values. You can switch between ECO and UPS mode at any time at the touch of a button, even if the inverter is not directly accessible.

Please note: The previous models ECTIVE RC1, RC2, RC3 and RC4 are not compatible with PRO series inverters.



ECTIVE MPPT Solar Charge Controller

Solar charge controllers are the link between the solar module and the battery, allowing for a self-sufficient power supply in which the batteries are charged with solar power. The technically advanced ECTIVE MPPT charge controllers automatically adjust their input voltage so that the solar system always delivers maximum power.

Supplement your mobile power supply with a charge controller from the ECTIVE SC, ECTIVE DSC or ECTIVE SC PRO series to utilise solar power and be truly independent.



ECTIVE Batteries

In combination with ECTIVE PRO inverters, modern ECTIVE LiFePO4 batteries are ideal for a reliable and efficient stand-alone power supply. The LC Slim BT, LC Under Seat BT and LC BT+LT series impress with their high maximum capacities, continuous discharge currents, convenient Bluetooth function and numerous other features. Of course, you can also use batteries with other technologies, such as AGM or gel.

ECTIVE Solar Panels

ECTIVE PRO inverters support solar panels up to 600 W and are therefore compatible with the entire ECTIVE solar panel range. Whether you are looking for light-weight panels, flexible ones or completely portable solar modules for ultimate independence: ECTIVE has the right solar panel series for every application.