

TSI 20 PRO

Power Inverter | 2000 W | 12 V to 230 V | Pure Sine Wave

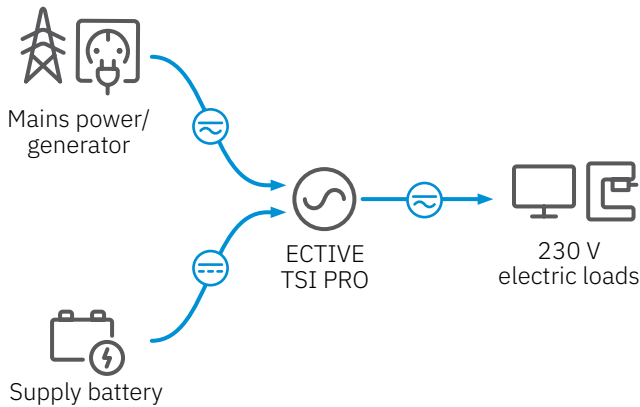

Versatile Power Supply



ECTIVE TSI PRO inverters convert direct current from a supply battery into high-quality alternating current with a pure sine wave. This means that sophisticated 230 V devices can be operated anywhere and anytime - exactly like with a power outlet at home.

Depending on requirements, the inverter works in mains or battery priority mode and can therefore be easily adapted to any situation. Furthermore, numerous safety functions and additional features such as a quiet fan and an integrated RCBO ensure a safe and efficient power supply.

Technical Specifications

Continuous power	2000 W
Max. Power up to 2 s	4000 W
Max. Power up to 10 s	3000 W
Input voltage	12 V
Output voltage	230 V
Efficiency (inverter)	up to 90 %
Dimensions (W x H x D)	445×220×120 mm
Weight (W x H x D)	6,1 kg
Direct current connection (DC)	M10

Required Battery Capacity

Battery capacity (Wet, Gel, AGM)	≥ 320 Ah
Battery capacity (LiFePO ₄)	≥ 180 Ah
Continuous discharge current (LiFePO ₄)	165 A

Features and Functions

- Alternating current with pure sine wave
- Battery priority circuit („ECO mode“)
- Mains priority circuit („UPS mode“)
- Provision of a TN power system
- Residual current circuit breaker with overcurrent protection (RCBO)
- Overload protection
- Short-circuit proof
- Soft start
- Over & under voltage protection
- Reverse polarity protection
- Overheating protection
- USB port for small devices (5 V / 1 A)

Dimensions

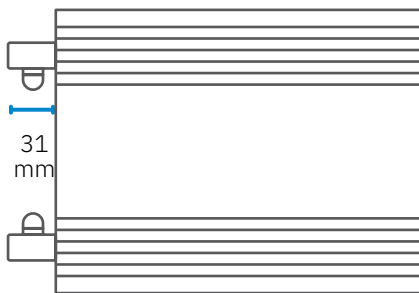
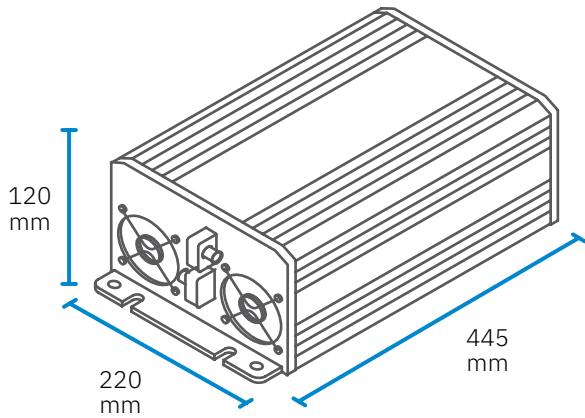

Protruding connectors

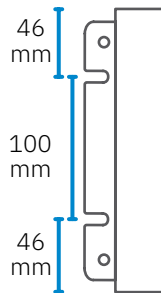

Mounting panel

Parameters of the Safety Features

Overvoltage	16,5 ± 0,2 V
Return after overvoltage	15,2 ± 0,2 V
Impending undervoltage	10,8 ± 0,2 V
Absolute undervoltage	10,2 ± 0,2 V
Undervoltage (ECO mode)	11,0 ± 0,2 V
Return after undervoltage	14,2 ± 0,2 V
Switchover time (UPS mode)	16 ms
Overheating	>75 °C
Working temperature	-15 to 40 °C
Storage temperature	-40 to 85 °C

The TSI PRO in the ECTIVE Ecosystem

Inverters from the ECTIVE TSI PRO series fit perfectly into the ECTIVE ecosystem, as they are compatible with batteries of all technologies. To keep the batteries charged easily, simply connect an external ECTIVE battery charger. With an additional ECTIVE MPPT solar charge controller, you can also use solar power to charge the batteries. This means that nothing stands in the way of an absolutely self-sufficient and mobile power supply that consists entirely of high-quality and perfectly harmonised ECTIVE products.

Would you like to add the right ECTIVE components to your system?
Find out more at active.de!

ECTIVE RC PRO

Simply connect the ECTIVE RC PRO remote control to your ECTIVE PRO inverter via the included RJ12 cable to easily monitor various relevant system values. You can switch between ECO and UPS mode at any time at the touch of a button, even if the inverter is not directly accessible.

Please note: The previous models ECTIVE RC1, RC2, RC3 and RC4 are not compatible with PRO series inverters.



ECTIVE Battery Charger

The ECTIVE range of charging technology has the right solution for every battery technology and all applications: The ECTIVE Multiload and Proload series are suitable for use with gel, AGM, wet and calcium batteries. For advanced LiFePO₄ batteries, use the ECTIVE Multiload LFP series, which were specifically designed for use with lithium batteries. Devices from the most recent series, ECTIVE Multiload PRO, can charge both conventional and LiFePO₄ batteries reliably and efficiently.



ECTIVE MPPT Solar Charge Controller

Solar charge controllers are the link between the solar module and the battery, allowing for a self-sufficient power supply in which the batteries are charged with solar power. The technically advanced ECTIVE MPPT charge controllers automatically adjust their input voltage so that the solar system always delivers maximum power.

Supplement your mobile power supply with a charge controller from the ECTIVE SC, ECTIVE DSC or ECTIVE SC PRO series to utilise solar power and be truly independent.



ECTIVE Batteries

In combination with ECTIVE PRO inverters, modern ECTIVE LiFePO₄ batteries are ideal for a reliable and efficient stand-alone power supply. The LC Slim BT, LC Under Seat BT and LC BT+LT series impress with their high maximum capacities, continuous discharge currents, convenient Bluetooth function and numerous other features. Of course, you can also use batteries with other technologies, such as AGM or gel.

ECTIVE Solar Panels

ECTIVE PRO inverters support solar panels up to 600 W and are therefore compatible with the entire ECTIVE solar panel range. Whether you are looking for light-weight panels, flexible ones or completely portable solar modules for ultimate independence: ECTIVE has the right solar panel series for every application.